

## Upright Trinocular Metallurgical Microscope with UIS and Dark Field Observation



iMet-220 upright metallurgical microscope is suitable to observe surfaces of opaque object. It equips with excellent UIS optical system and modularization function design so that update system expediently and achieved polarization, dark field observation.

Compact and steady main frame body is embodiment for the shock resistance. The ideal ergonomic design is adopted in this unit and has easier operation and wider space.

iMet-220 is an ideal optical instrument for micro observation in metallographic structure and surface morphology suitable for research in metallography, mineralogy, precision engineering, etc.

### Features:

▲ With long working distance plan achromatic objectives (no cover glass) and wide-field eyepieces, can get clear pictures and wide view field

▲ Trinocular, can switch to normally/polarize observation, bright field/dark field observation. can send 100% of light to the binocular eyepieces or to the top port

### Standard Configuration:

Eyeiece	Wide Field WF10X (field number:Φ22mm)	
Infinity plan achromatic objective	iMet-220 Equipped with bright field objectives	PL L5X/0.12 (Work distance): 26.1 mm
		PL L10X/0.25 (Work distance): 20.2 mm
		PL L20X/0.40 (Work distance): 8.80 mm
		PL L50X/0.70 (Work distance): 3.68 mm
		PL L80X/0.80 (Work distance): 1.25 mm
	iMet-220BD Equipped with bright & dark field objectives	PL L5X/0.12BD (Work distance): 8.05mm
		PL L10X/0.25BD (Work distance): 7.86mm
		PL L20X/0.40BD (Work distance): 7.23mm
		PL L50X/0.70BD (Work distance): 1.75mm
		PL L80X/0.80BD (Work distance): 1.25 mm
Eyepieces tube	Trinocular inclined 30°, can be shot in 100% light flux.	
Epi- illumination system	iMet-220	6V30W halogen and brightness enable control
	iMet-220BD	12V50W halogen and brightness enable control
	Integrated field diaphragm, aperture diaphragm and (Y,B,G, ground glass) switching device. Push-pull type analyzer and polarizer.	
Focus system	Coaxial coarse/fine focus system, with tension adjustable and limit stopper, minimum division of fine focusing: 0.8μm.	
Nosepiece	Quintuple (Backward ball bearing inner locating)	
Stage	Mechanical stage overall size: 280mmX270mm, moving range: 204mmX204mm	

# Image Analysis Software META VISION

## Applications:

META VISION is an advanced metallurgical software, and suit a wide range of metallurgical applications with utmost metallurgical analysis & investigations. It is user friendly & very convenient to other equivalent metallurgical software.

## Functions:

- (A) Image Editing & View;
- (B) Morphometry Measurement;
- (C) Image Processing;
- (D) Routine Filters;
- (E) Special Filters;
- (F) Edge Detection.

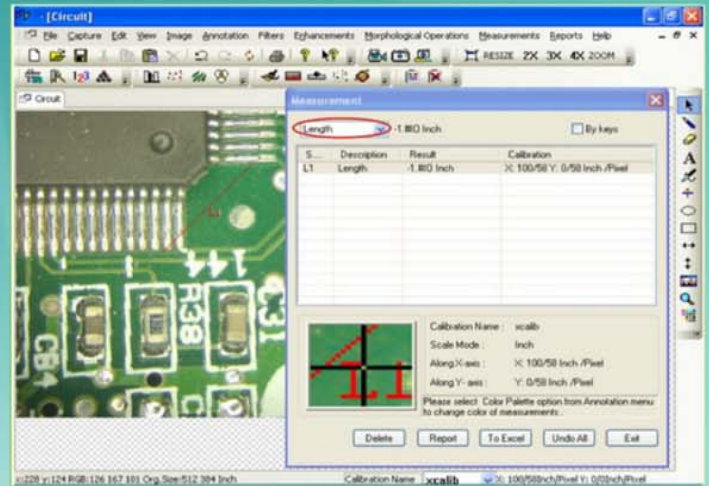

Image Analysis Software META VISION (433-101)

## Features:

META VISION is suitable for a wide range of Image Analysis functions and the prominent functions are described hereunder:

### 1. Calibration:

- a) Special calibration, with Japanese test slide JIS ( 0.01mm);
- b) Area by enclosed line controlled by four arrow keys available on keyboard arrows with zoomed Preview.

### 2. Count & Classification:

Identification of objects in an image, count them, obtain several features measurements. Objects identification by user or automatically. User defined classification on basis of size and intensity.

### 3. Threshold Practical Measurement:

Manual, auto bright and auto dark methods to identify Intensity range defined object to be measured. Various calculations & measurements available for selected particle are: dimensions, area, parameter feret, length, thread length, thread & fiber width,

### 4. Morphometry Measurements:

Line measurements for distance, length, width perimeter, angle, three point radius. Roundness, shape, orientation, elongation, equal circular diameter, equal sphere volume.

### 5. Locational Analysis:

Centroid X, Centroid Y, Major X1, Major Y1, Minor X1, Minor Y1, Major X2, Major Y2, Minor X2, Minor Y2, Box X2, Box Y2 & Box Area.

### 6. Phase Analysis:

Measure area fraction & volume fractions. Identify multiple phases with Micro structure. Also delineate phase from the histogram as per ASTM standard E562 & E1245.SS.

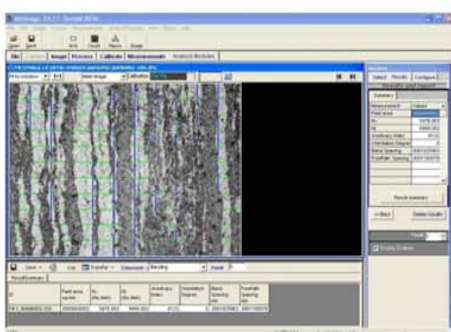

Measure carbide banding levels according to ASTM E1268

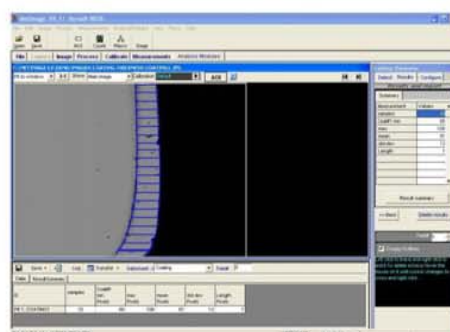

Measure cross sectional thickness according to ASTM B487

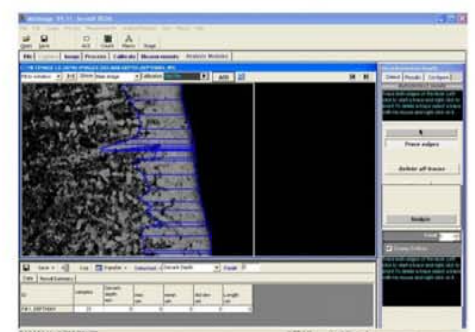

Measure Decarb Depth according to ASTM E 1077

META VISION



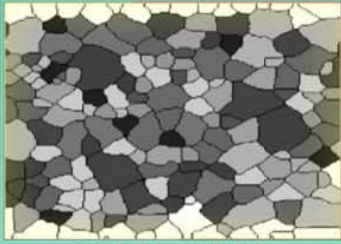

Grain Size (ASTM)

### 7. Nodularity:

Measure Nodularity as per ASTM 247 standard. The Nodules & Flakes are separated on the basis of its shape and aspect ratio. The detail measurement of each micro structure is available for further analysis. The processed image displays non-Nodules in different color. The Nodules can be classify by its range on the basis of its size & shape.

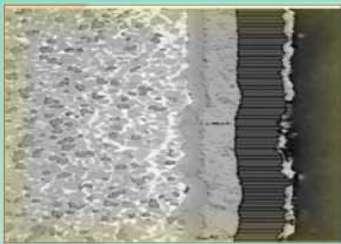

Coating Thickness

### 8. Porosity:

They are recognized on the basis of its intensity as per ASTM B-276 standard. The measurement of each pores displayed. The processed image displays pores in Red Color.

### 9. Coating Thickness:

This application rapidly measures the thickness or width of a coating at multiple positions along a sample as per ASTM B487 Standards. Tabulated results available for min/max and mean of width Measured at various points of sample cross section.

### 10. Decarburisation:

Measured depth or width of decarburisation occurs as per ASTM 1077 standards.

### 11. Grain Size:

The module analysis Grain image and measure the Grain No & Grain size using ASTM E 112 method. The option for measurement available are: 1. Manual trace; 2. Popular comparison method; 3. Quick single grain measurement; 4. ALA method; 5. Interception method. Various filters to make use defined templates. Grain boundary repair mathematical function.



Counting

### 12. Non-Metallic Inclusion:

Measure inclusions and report ASTM E-45, E-1245 numbers, cumulative length width ratio.

### 13. Graphic Flakes:

Graphite Flakes length, Width distribution and Percentage as per ASTMA-247-67.

### 14. Report:

- a) Direct printout with original image, processed image & Tabular results.
- b) Export to MS EXCEL for further modifications.

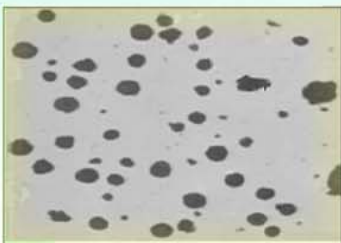

Nodularity

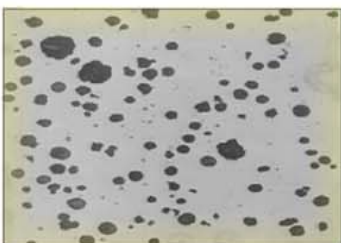
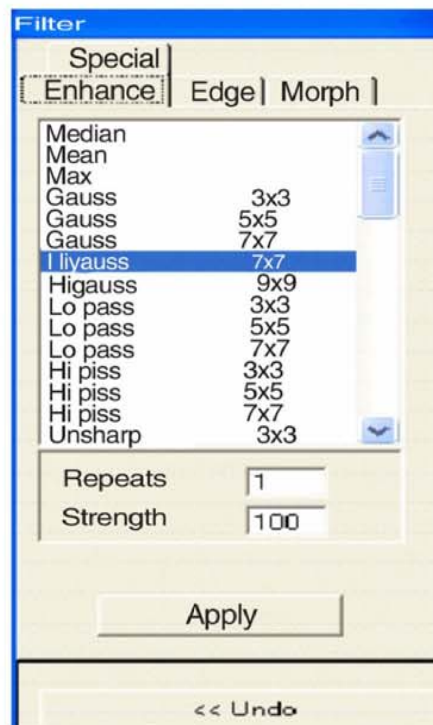

Porosity

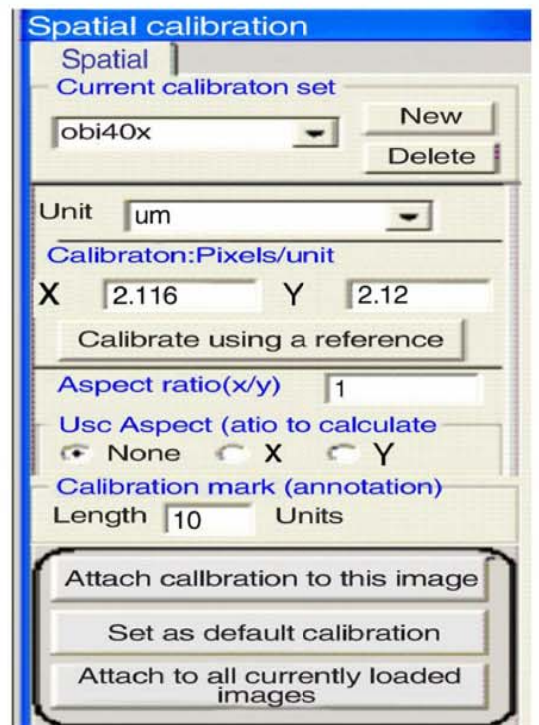

Segmentation

### iqualitrol C-mount USB2.0 CMOS Camera



- Standard C-Mount camera with Aptina CMOS sensor;
- With hardware resolution among 0.35M to 14M;
- Integrated zinc aluminum alloy housing;
- USB2.0 interface ensuring high speed data transmission;
- Ultra-Fine color engine with perfect color reproduction capability;
- With advanced video & image processing application;
- Providing Windows/Linux/OSX multiple platform SDK;
- Native C/C++, C#, DirectShow, Twain Control API;

Ultra-high performance CMOS camera and it adopts ultra-high performance CMOS sensor as the image-picking device. USB2.0 is used as the data transfer interface.

CMOS camera hardware resolutions range from 0.35M to 14M and comes with the Integrated zinc aluminum alloy compact housing.

CMOS comes with advanced video & image processing application; Providing Windows/Linux/OSX multiple platform SDK; Native C/C++, C#/VB.NET, DirectShow, Twain Control API;

CMOS can be widely used in brightfield light environment and microscope image capture and analysis with moderate frame rate.

#### USB2.0 CMOS Camera Dimension

Installation drawings. The CMOS Series USB2.0 Camera body, made from tough, CNC alloy, ensures a heavy duty, workhorse solution.

The camera is designed with a high quality IR-CUT to protect the camera sensor. No moving parts included. This design ensures a rugged, robust solution with an increased lifespan when compared to other industrial camera solutions.

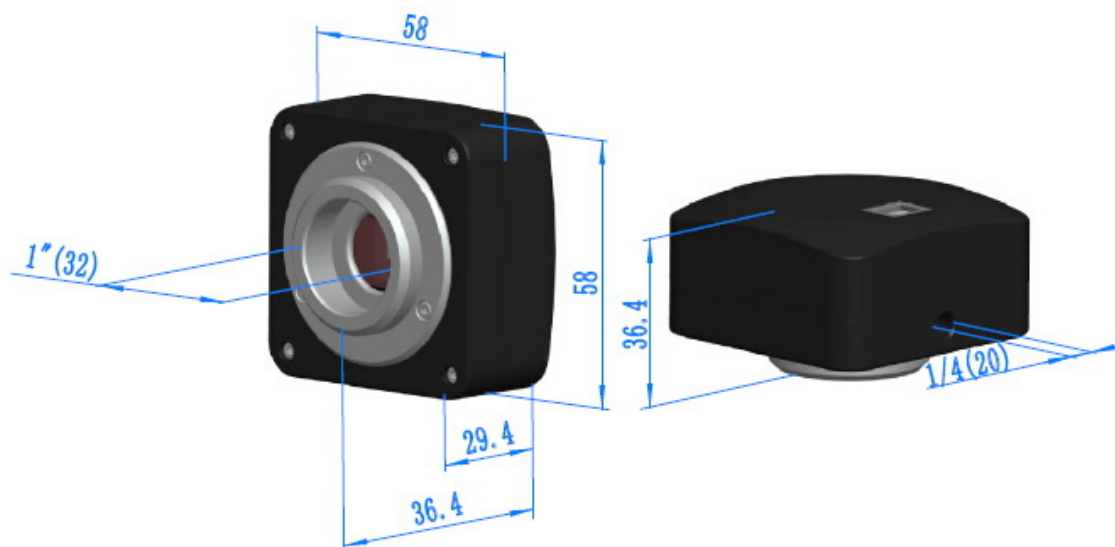

Order Code	Sensor & Size(mm)	Pixel( $\mu\text{m}$ )	G Sensitivity Dynamic Range SN Ratio	FPS/Resolution	Binning	Exposure
CMOS14000KPA TP614000A	14M/MT9F002(C) 1/2.3"(5.73x4.60)	1.4x1.4	0.724v/lux-sec 65.3dB 35.5dB	1.8@4096x3288 10@2048x1644 27@1024x822	1x1,2x2,4x4	0.4ms~2000ms
CMOS10000KPA TP610000A	10M/MT9J003(C) 1/2.3"(5.98x4.59)	1.67x1.67	0.31v/lux-sec 65.2dB 34dB	1.9@3584x2748 8@1792x1374 27@896x684	1x1,2x2,4x4	0.4ms~2000ms
CMOS09000KPB TP609000B	9.0M/Special(C) 1/2.4"(5.83x4.37)	1.67x1.67	0.31v/lux-sec 65.2dB 34dB	1.9@3488x2616 8@1744x1308 27@872x654	1x1,2x2,4x4	0.4ms~2000ms
CMOS08000KPB TP608000B	14M/Special(C) 1/2.5"(5.45x4.09)	1.67x1.67	0.31v/lux-sec 65.2dB 34dB	1.9@3264x2448 8@1600x1200 27@800x600	1x1,2x2,4x4	0.4ms~2000ms
CMOS05100KPA TP605100A	5.1M/MT9P006(C) 1/2.5"(5.70x4.28)	2.2x2.2	0.53 V/lux-sec 66.5dB 40.5dB	5@2592x1944 18@1280x960 60@640x480	1x1,2x2,4x4	0.294ms~2000ms
CMOS03100KPA TP603100A	3.1M/MT9T001(C) 1/2"(6.55x4.92)	3.2x3.2	1.0 V/lux-sec 61dB 43dB	8@2048x1536 22@1024x768 43@680x510	1x1,2x2,3x3	0.244ms~2000ms
CMOS02000KPB TP602000B	2.0M/Special(C) 1/2.6"(5.12x3.84)	3.2x3.2	1.0 V/lux-sec 61dB 43dB	16@1600x1200 50@800x600	1x1,2x2	0.244ms~2000ms
CMOS01300KPA TP601300A	1.3M/MT9M111(C) 1/3"(4.60x3.70)	3.6x3.6	1.0V/lux-sec 71dB 44dB	15@1280x1024 26@640x512 50@320x256	1x1,2x2,4x4	0.14ms~2000ms
CMOS01300KMA TM601300A	1.3M/MT9M001(M) 1/2"(6.66x5.32)	5.2x5.2	2.1 V/lux-sec 68.2dB 45dB	20@1280x1024	1x1	0.14ms~500ms
CMOS00350KPA TP600350A	0.35M/MT9V011(C) 1/4"(3.58x2.69)	5.6x5.6	1.9V/lux-sec 60dB 45dB	30@640x480 80@320x240	1x1,2x2	0.111ms~192.6ms

**OTHER HARDWARE CONFIGURATION**

Spectral Range	380-650nm (with IR-filter)
White Balance	ROI White Balance/ Manual Temp-Tint Adjustment
Color Rendering Technique	Ultra Fine Color Engine
Capture/Control API	Native C/C++, C#, Directshow, Twain, Labview
Recording System	Still Picture and Movie

Cooling System*	Natural
<b>OPERATING ENVIRONMENT</b>	
Operating Temperature	-10°C ~ 50°C
Storage Temperature	-20°C ~ 60°C
Operating Humidity	30~80%RH
Storage Humidity	10~60%RH
Power Supply	DC 5V over PC USB Port
<b>SOFTWARE ENVIRONMENT</b>	
Operating System	Support Microsoft Windows XP / Vista / 7 / 8 (32 & 64 bit) OS X (Mac OS X), Linux
PC Requirements	CPU: Equal to Intel Core2 2.8GHz or Higher
	Memory: 2GB or More
	USB port: USB2.0 High-speed Port
	Display: 17" or Larger
	CD-ROM